

Model Rules for Reporting by Digital Platform Operators

XML Schema

User Guide for Tax Administrations



March 2022

Model Rules for Reporting by Digital Platform Operators XML Schema: User Guide for tax administrations

Version 1.0 - February 2022

This document, as well as any data and any map included herein, are without prejudice to the status of or sovereignty over any territory, to the delimitation of international frontiers and boundaries and to the name of any territory, city or area.

This document was approved by the Committee on Fiscal Affairs on 17 March 2022 and prepared for publication by the OECD Secretariat.

Please cite this publication as:

OECD (2022), *Model Rules for Reporting by Digital Platform Operators XML Schema: User Guide for Tax Administrations*, OECD, Paris, <https://www.oecd.org/tax/exchange-of-tax-information/model-rules-for-reporting-by-digital-platform-operators-xml-schema-user-guide-for-tax-administrations.pdf>.

Photo credits: © everything possible – Shutterstock.com

© OECD 2022

The use of this work, whether digital or print, is governed by the Terms and Conditions to be found at www.oecd.org/termsandconditions

Table of contents

Abbreviations and acronyms	4
Introduction	5
How the DPI User Guide links to the DPI Schema	5
DPI Schema Information	7
I. Message Header	7
II. Organisation Party Type	9
III. PersonParty Type	14
IV. DPI Body	18
Corrections	33
Introduction	33
Technical Guidance	33
Annex 1.A. DPI XML Schema v. 1.0 Diagrams	36
Annex 1.B. Glossary of Namespaces	47

Abbreviations and acronyms

CTS	Common Transmission System
XML	Extendable Mark-up Language
OECD	Organisation for Economic Co-operation and Development
CA	Competent Authority
DPI MCAA	Multilateral Competent Authority Agreement on Automatic Exchange of Information on Income Derived through Digital Platforms
OECD Model Rules	OECD Model Rules for Reporting by Platform Operators with respect to Sellers in the Sharing and Gig Economy
OECD Extended Scope	The extension to the scope of the OECD Model Rules to also cover the sale of Goods and the rental of a means of transportation
EU DIR2021/514 (DAC7)	Council Directive (EU) 2021/514 of 22 March 2021 amending Directive 2011/16/EU on administrative cooperation in the field of taxation

Introduction

How the DPI User Guide links to the DPI Schema

The Schema for exchanges by Digital Platforms (DPI) User Guide is divided into logical sections based on the schema and provides information on specific data elements and any attributes that describe each data element.

The main sections of the DPI Schema User Guide are:

1. The Message Header with the sender, recipient, message type and reporting period
2. The Organisation Party type, used for identifying entities, i.e. both Platform Operators and Entity Sellers
3. The Person Party type, used for identifying individual Sellers
4. The DPI Body, which contains three sub-sections –
 - a) Platform Operator, containing the required information with respect to the Reporting Platform Operator that is reporting pursuant to the OECD Model Rules
 - b) Other Platform Operators, containing the information on the Other Platform Operators –
 - I. The Platform Operator assuming the reporting in the name of the Reporting Platform Operator; and
 - II. Each Platform Operator for which the Reporting Platform Operator assumes the reporting.
 - c) Reportable Seller, containing information on the Reportable Seller's –
 - III. Identity, which identifies the individual or Entity Reportable Seller subject to exchange under the OECD Model Rules; and
 - IV. Relevant Activities, which includes information on the Relevant Activities provided by such Reportable Seller and the Consideration derived therefrom.

The DPI XML Schema is designed to be used for the exchange of information reported under the OECD Model Rules between competent authorities that have activated exchange relationships under the Multilateral Competent Authority Agreement on Automatic Exchange of Information on Income Derived through Digital Platforms (“DPI MCAA”), or similar exchange instrument.

Reflecting the design of the DPI MCAA, the DPI XML Schema foresees the possibility to exchange information in respect of a wide range of Relevant Activities provided by Reportable Sellers, namely:

The original scope of the OECD Model Rules, covering the rental of immovable property and the provision of Personal Services; and

The OECD Extended Scope, also covering the sale of goods and the rental of a means of transportation, which reflects the scope of Council Directive (EU) 2021/514, further referred to as [EU DIR2021/514].

Unless specified otherwise, all references to the OECD Model Rules also apply to the OECD Extended Scope.

Where appropriate, jurisdictions could also consider using the schema domestically for the purpose of gathering the required information from their respective Reporting Platform Operators.

The requirement field for each data element and its attribute indicate whether the element is validation or optional in the schema. Every element is one or the other in the schema.

“Validation” elements MUST be present for ALL data records in a file and an automated validation check can be undertaken. The Sender should do a technical check of the data file content using XML tools to make sure all “Validation” elements are present and if they are not, correct the file. The Receiver may also do so and, if incorrect, may reject the file.

“Optional (mandatory)” elements must be provided when available and/or required by the OECD Model Rules or by the [EU DIR2021/514].

“Optional” elements may be provided, but are not required to be filled in.

Appendix A to the DPI User Guide shows a diagrammatic representation of the DPI XML Schema with all its elements.

Appendix B to the DPI User Guide contains a Glossary of namespaces for the DPI XML Schema.

DPI Schema Information

I. Message Header

The information in the message header identifies the tax administration that is sending the DPI message. It specifies when the message was created, what reporting period the report is for, and the nature of the report (original, correction, deletion, etc.).

Element	Attribute	Size	Input Type	Requirement
SendingEntityIN		1 to 200 characters	stf:StringMin1Max200_Type	Optional

Although not used for exchanges between Competent Authorities under the DPI MCAA and [\[EU DIR2021/514\]](#), for domestic reporting, this data element can be used in case the schema is mandated for domestic reporting by Reporting Platform Operators to their tax administration. In such instances, it identifies the Reporting Platform Operator sending the message through a domestically-defined identification number.

Element	Attribute	Size	Input Type	Requirement
TransmittingCountry		2-character	iso:CountryCode_Type	Validation

This data element identifies the jurisdiction of the Competent Authority transmitting the DPI message.

It uses the 2-character alphabetic country code and country name list¹ based on the ISO 3166-1 Alpha 2 standard.

Element	Attribute	Size	Input Type	Requirement
ReceivingCountry		2-character	iso:CountryCode_Type	Validation

This data element identifies the jurisdiction of the Competent Authority receiving the DPI message.

It uses the 2-character alphabetic country code and country name list based on the ISO 3166-1 Alpha 2 standard.

Element	Attribute	Size	Input Type	Requirement
MessageType			dpi:MessageType_EnumType	Validation

This data element specifies the type of message being sent. The only allowable entry for messages exchanged under the Model Rules in this field is “DPI”.

[\[EU Specific\]](#) The only allowable entry in this field for messages exchanged under [\[EU DIR2021/514\]](#) is “DAC7”.

¹ The following disclaimer refers to all uses of the ISO country code list in the Digital Platforms Schema. For practical reasons, the list is based on the ISO 3166-1 country list. The use of this list does not imply the expression by the OECD of any opinion whatsoever concerning the legal status of the territories listed. Its content is without prejudice to the status of or sovereignty over any territory, to the delimitation of international frontiers and boundaries and to the name of any territory, city or area.

Element	Attribute	Size	Input Type	Requirement
Warning		1 to 4'000 characters	stf:StringMin1Max4000_Type	Optional

This data element is a free text field allowing input of specific cautionary instructions about the use of the DPI message content.

Element	Attribute	Size	Input Type	Requirement
Contact		1 to 4'000 characters	stf:StringMin1Max4000_Type	Optional

This data element is a free text field allowing input of specific contact information relating to the sender of the message.

In international exchanges, this data element contains the contact details of the sending competent authority.

Element	Attribute	Size	Input Type	Requirement
MessageRefID		1 to 170 characters	stf:StringMin1Max170_Type	Validation

This data element is a free text field capturing the sender's unique message identifier (created by the sender) that identifies the particular message being sent. The identifier allows both the sender and receiver to identify the specific message later, if questions arise. The Message RefID must start with the country code of the sending jurisdiction, then the year of the reportable period, then the receiving country code before a unique identifier. An example of such identifier is provided in the Corrections section below.

Element	Attribute	Size	Input Type	Requirement
MessageTypeIndic			dpi:DPIMessageType Indic_EnumType	Validation

This data element specifies the type of information that is sent, i.e. whether it is new information or whether the message seeks to correct or delete previously sent information. As such, the possible values:

DPI401 – The message contains new (including additional) information

DPI402 – The message contains corrections/deletions for previously sent information

DPI403 – The message advises that there is no data to report. The value DPI403 should be selected in the following cases:

- a) in an international context, where the Sending Country wishes to communicate to the Receiving Country that no data on Reportable Sellers is to be exchanged for the Reportable Period to which the message relates, in which case the DPI Body element should be omitted;
- b) in a domestic context, where there is no information to be reported by a Reporting Platform Operator (domestic nil reporting);
- c) in a domestic context, when there is no Reportable Seller information, because a Platform Operator in another jurisdiction is assuming reporting obligations for the Reporting Platform Operator.

Element	Attribute	Size	Input Type	Requirement
ReportingPeriod			xsd:date	Validation

This data element identifies the year to which the information in the DPI message relates in yyyy-MM-DD format, on the basis of the calendar year in which the relevant Reportable Period under the OECD Model Rules or [EU Specific] [EU DIR2021/514] ended. For example, if the information relates to the 2022 Reportable Period, the field would read "2022-12-31".

Element	Attribute	Size	Input Type	Requirement
---------	-----------	------	------------	-------------

Timestamp	xsd:dateTime	Validation
-----------	--------------	------------

This data element identifies the date and time when the message was compiled. It is anticipated that this element will be automatically populated by the host system. The format for use is yyyy-MM-DD'T'hh:mm:ss.nnn. Fractions of seconds may be used (in such a case the milli-seconds will be provided on 3 digits, see “.nnn” in the format above). Examples: 2015-03-15T09:45:30 or 2015-03-15T09:45:30.789 (with milli-seconds).

II. Organisation Party Type

The organisation type defines the information to be included in the DPI XML Schema in relation to an entity, in particular the Reporting Platform Operator or an Entity Seller.

It is comprised of the following elements, of which details are set out further below:

Element	Attribute	Size	Input Type	Requirement
ResCountryCode		2-character	iso:CountryCode_Type	Optional (Mandatory)

Element	Attribute	Size	Input Type	Requirement
TIN		0 to 200 characters	dpi:TIN_Type	Validation

Element	Attribute	Size	Input Type	Requirement
IN		1 to 200 characters	dpi:OrganisationIN_Type	Optional (Mandatory)

Element	Attribute	Size	Input Type	Requirement
VAT		1 to 200 characters	stf:StringMin1Max200_Type	Optional (Mandatory)

Element	Attribute	Size	Input Type	Requirement
Name		1 to 200 characters	dpi:NameOrganisation_Type	Validation

Element	Attribute	Size	Input Type	Requirement
PlatformBusinessName		1 to 200 characters	stf:StringMin1Max200_Type	Optional (Mandatory)

Element	Attribute	Size	Input Type	Requirement
Address			dpi:Address_Type	Validation

Element	Attribute	Size	Input Type	Requirement
Nexus			dpi:Nexus_EnumType	Optional (Mandatory)

Element	Attribute	Size	Input Type	Requirement
AssumedReporting			xsd:boolean	Optional (Mandatory)

ResCountryCode

Element	Attribute	Size	Input Type	Requirement
ResCountryCode		2-character	iso:CountryCode_Type	Optional (Mandatory)

This repeatable data element describes the residence country code(s) of the entity. In case of an Entity Seller this should always be present and should correspond to the jurisdiction of residence identified on the basis of the due diligence requirements of the OECD Model Rules or [EU Specific] [EU DIR2021/514]. Specifically, under the OECD Model Rules, the residence country code of an Entity Seller should correspond to the jurisdiction in which its registered office is located.

In case of a Reporting Platform Operator, the residence country code should correspond to the jurisdiction where the Reporting Platform Operator is resident for tax purposes or, where it does not have a residence for tax purposes, either the jurisdiction it is incorporated under or the jurisdiction that it has its place of management (including effective management) in, [EU Specific] or the Member State where it has a permanent establishment in.

[EU Specific]: Reporting Platform Operator: This element is optional.

TIN (TIN_Type)

Element	Attribute	Size	Input Type	Requirement
TIN		0 to 200 characters	dpi:TIN_Type	Validation

This repeatable data element provides the tax identification number (TIN) used by the tax administration of the jurisdiction of residence of the entity. In case the entity does not have a TIN, or the TIN is not known² to the sending Competent Authority, the value “NOTIN” should be entered [OECD Specific] and the Unknown attribute (see below) must be set to “true”. Furthermore, in case more than one TIN are provided, any provided element cannot be flagged as “unknown”. This element must be present for both Reporting Platform Operator and Entity Seller.

Element	Attribute	Size	Input Type	Requirement
TIN	issuedBy	2-character	iso:CountryCode_Type	Optional (Mandatory)

This attribute describes the jurisdiction that issued the TIN. It should always be provided, unless the TIN element is flagged as “unknown”.

Element	Attribute	Size	Input Type	Requirement
TIN	unknown	1-character	xsd:Boolean	Optional

This attribute can be provided if the TIN is not available or inexistent². Any value provided for a TIN flagged as unknown will be discarded.

Entity IN (OrganisationIN_Type)

Element	Attribute	Size	Input Type	Requirement
IN		1 to 200 characters	dpi:OrganisationIN_Type	Optional (Mandatory)

This data element can be provided (and repeated) if there are other INs available, such as a company registration number or an Entity Identification Number (EIN).

[EU Specific]:

Reporting Platform Operator: Where relevant, the individual identification number (IIN) shall be provided

² For instance, when the Entity Sellers reside in a country where TIN is not provided.

Entity Seller: The business registration number (BRN) must be provided

Element	Attribute	Size	Input Type	Requirement
IN	issuedBy	2-character	iso:CountryCode_Type	Optional (Mandatory)

This attribute describes the jurisdiction that issued the IN. If the issuing jurisdiction is not known then this element may be omitted.

Element	Attribute	Size	Input Type	Requirement
IN	INType		dpi:INType_EnumType	Validation

This attribute defines the type of identification number being sent among the following:

[EU Specific]: IIN for the reporting of an individual³ identification number;

LEI for the reporting of a legal entity identifier;

EIN for the reporting of an entity identification number;

BRN for the reporting of a business registration number; or

Other.

VAT

Element	Attribute	Size	Input Type	Requirement
VAT		1 to 200 characters	stf:StringMin1Max200_Type	Optional (Mandatory)

This data element can be provided when a VAT Identification number is available.

Organisation Name

Element	Attribute	Size	Input Type	Requirement
Name		1 to 200 characters	dpi:NameOrganisation_Type	Validation

This element should contain the legal name of the entity, including the domestic designation for the legal form, as indicated in its articles of incorporation or any similar document.

PlatformBusinessName

Element	Attribute	Size	Input Type	Requirement
PlatformBusinessName		1 to 200 characters	stf:StringMin1Max200_Type	Optional (Mandatory)

The repeatable Platform Business Name element identifies the business name(s) of Platform(s) in respect of which the Reporting Platform Operator is reporting.

This element must not be used for Entity Sellers.

Address (Address_Type)

Element	Attribute	Size	Input Type	Requirement
CountryCode		2-character	iso:CountryCode_Type	Validation

This data element provides the country code associated with the entity's (or person's) address.

Element	Attribute	Size	Input Type	Requirement
AddressFree		1 to 4'000 characters	stf:StringMin1Max4000_Type	Validation

³ Note that "Individual" does not mean or refer to a natural person.

This data element allows input of address information in free text. It should only be used in exceptional circumstances when it is impossible to provide the address in the fixed format.

Element	Attribute	Size	Input Type	Requirement
AddressFix			dpi:AddressFix_Type	Validation

This data element allows input of address information in fixed format.

Element	Attribute	Size	Input Type	Requirement
AddressFree		1 to 4'000 characters	stf:StringMin1Max4000_Type	Optional

This data element can only be used in addition to an address in a fixed format.

It permits to include an address in a free format (AddressFree) or in a fixed format (AddressFix) or both formats, i.e. by permitting to add an address in a free format after the fixed format. This ensures that, at least, an address is provided but also both, if the Reporting Platform Operator desires.

Element	Attribute	Size	Input Type	Requirement
Address	legalAddressType		dpi:OECDLegalAddressType_EnumType	Optional

OECDLegalAddressType_EnumType

This is a datatype for an attribute to an address. It serves to indicate the legal character of that address (residential, business etc.).

The possible values are:

- OECD301= residentialOrBusiness
- OECD302= residential
- OECD303= business
- OECD304= registeredOffice
- OECD305= unspecified

The address of the Reportable Platform Operator must represent the “Registered Office Address” (OECD304).

Address Fix (AddressFix_Type)

Element	Attribute	Size	Input Type	Requirement
Street		1 to 200 characters	stf:StringMin1Max200_Type	Optional

Element	Attribute	Size	Input Type	Requirement
BuildingIdentifier		1 to 200 characters	stf:StringMin1Max200_Type	Optional

Element	Attribute	Size	Input Type	Requirement
SuiteIdentifier		1 to 200 characters	stf:StringMin1Max200_Type	Optional

Element	Attribute	Size	Input Type	Requirement
FloorIdentifier		1 to 200 characters	stf:StringMin1Max200_Type	Optional

Element	Attribute	Size	Input Type	Requirement
DistrictName		1 to 200 characters	stf:StringMin1Max200_Type	Optional

Element	Attribute	Size	Input Type	Requirement
POB		1 to 200 characters	stf:StringMin1Max200_Type	Optional

Element	Attribute	Size	Input Type	Requirement
PostCode		1 to 200 characters	stf:StringMin1Max200_Type	Optional

Element	Attribute	Size	Input Type	Requirement
City		1 to 200 characters	stf:StringMin1Max200_Type	Validation

Element	Attribute	Size	Input Type	Requirement
CountrySubentity ⁴		1 to 200 characters	stf:StringMin1Max200_Type	Optional

Nexus (Nexus_EnumType)

Element	Attribute	Size	Input Type	Requirement
Nexus			dpi:Nexus_EnumType	Optional (Mandatory)

[EU Specific] This data element provides the reason for which the information will be reported to the competent authority of the EU Member State on the basis of subparagraph A(4) of section I of Annex V in [EU DIR2021/514].

The possible values are:

- RPONEX1 = The Reporting Platform Operator is resident for tax purposes in the EU Member State
- RPONEX2 = The Reporting Platform Operator does not have a residence for tax purposes but it is incorporated under the laws of the EU Member State
- RPONEX3 = The Reporting Platform Operator does not have a residence for tax purposes but it has its place of management (including effective management) in the EU Member State
- RPONEX4 = The Reporting Platform Operator does not have a residence for tax purposes but it has a permanent establishment in the EU Member State and it is not a Qualified Non-Union Platform Operator
- RPONEX5 = The Reporting Platform Operator is neither resident for tax purposes, nor incorporated or managed in the EU Member State, nor has a permanent establishment in the EU Member State but it facilitates the carrying out of a Relevant Activity by Reportable Sellers or a Relevant Activity involving the rental of immovable property located in the EU Member State and it is not a Qualified Non-Union Platform Operator

This data element must not be used for Entity Sellers.

⁴ This represents a state, region or department.

AssumedReporting

Element	Attribute	Size	Input Type	Requirement
AssumedReporting			xsd:boolean	Optional (Mandatory)

The Assumed Reporting element identifies whether the Reporting Platform Operator is not reporting information on Reportable Sellers, because another Reporting Platform Operator has assumed the reporting.

When “AssumedReporting” is set to “true”, it means that another Reporting Platform Operator reported for the Reporting Platform Operator. Otherwise, this element must be set to “false”.

This element is mandatory for Reporting Platform Operator and must not be provided for an Entity Seller.

By way of an example, Platform Z is operated by two Platform Operators: Platform Operator 1 (resident in jurisdiction 1) and Platform Operator 2 (resident in jurisdiction 2). In satisfying the reporting requirements, Platform Operator 1 has obtained assurances from Platform Operator 2 that it will fulfil the reporting obligations with respect to all of the Reportable Sellers of Platform Operator 1 in jurisdiction 2.

Platform Operator 1 will therefore provide its identification information and set the AssumedReporting element to “true” to notify its jurisdiction residence (jurisdiction 1) that it has relied on another Platform Operator to fulfil the reporting requirements. Platform Operator 1 will also use the AssumingPlatformOperator element (discussed further below) to report to its jurisdiction (jurisdiction 1) identification information on Platform Operator 2, assuming the reporting obligation in the name of Platform Operator 1. Platform Operator 1 will not provide ReportableSeller element.

At the same time, Platform Operator 2 will use the AssumedPlatformOperator element (discussed further below) to report to its jurisdiction of residence (jurisdiction 2) identification information on Platform Operator 1, for which it has assumed reporting obligations, and complete the Platform Operator element for itself.

[EU Specific] This element is optional for the purposes of [EU DIR2021/514].

III. PersonParty Type

The data elements in this section are used to provide identification information on individual Sellers. This complex type is comprised of the following six data elements that are further set out below:

Element	Attribute	Size	Input Type	Requirement
ResCountryCode		2-character	iso:CountryCode_Type	Validation

Element	Attribute	Size	Input Type	Requirement
TIN		0 to 200 characters	dpi:TIN_Type	Validation

Element	Attribute	Size	Input Type	Requirement
VAT		1 to 200 characters	stf:StringMin1Max200_Type	Optional (Mandatory)

Element	Attribute	Size	Input Type	Requirement
Name			dpi:NamePerson_Type	Validation

Element	Attribute	Size	Input Type	Requirement
Address			dpi:Address_Type	Validation

Element	Attribute	Size	Input Type	Requirement
Nationality			iso:CountryCode_Type	Optional

Element	Attribute	Size	Input Type	Requirement
BirthInfo				Validation

ResCountryCode

Element	Attribute	Size	Input Type	Requirement
ResCountryCode		2-character	iso:CountryCode_Type	Validation

This repeatable data element describes the residence country code(s) of the individual Seller and must be present in all data records. This should correspond to the jurisdiction of residence identified on the basis of the due diligence requirements of the OECD Model Rules or [\[EU Specific\]](#) [EU DIR2021/514]. Specifically, under the OECD Model Rules, the residence country code of an individual Seller should correspond to the jurisdiction of the Seller's primary residence.

TIN Type

Element	Attribute	Size	Input Type	Requirement
TIN		0 to 200 characters	dpi:TIN_Type	Validation

This repeatable data element provides the tax identification number (TIN) used by the tax administration of the jurisdiction of residence of the individual Seller. In case the individual Seller does not have a TIN, the jurisdiction of residence does not issue a TIN or require the collection of the TIN issued to such Seller, or the TIN is not known to the sending Competent Authority, the Unknown attribute (see below) must be set to "true" and the value "NOTIN" should be entered [\[OECD Specific\]](#). Furthermore, in case more than one TIN are provided, any provided element cannot be flagged as "unknown".

Element	Attribute	Size	Input Type	Requirement
TIN	issuedBy	2-character	iso:CountryCode_Type	(Optional) Mandatory

This attribute describes the jurisdiction that issued the TIN. It should be always provided, unless the TIN element is flagged as "unknown".

Element	Attribute	Size	Input Type	Requirement
TIN	unknown	1-character	xsd:Boolean	Optional

This attribute must be provided if the TIN is not available or inexistent. Any value provided for a TIN flagged as unknown will be discarded.

VAT

Element	Attribute	Size	Input Type	Requirement
VAT		1 to 200 characters	stf:StringMin1Max200_Type	Optional (Mandatory)

This data element must be provided if there is a VAT Identification number available.

NamePerson_Type

Element	Attribute	Size	Input Type	Requirement
Name			dpi:NamePerson_Type	Validation

This data element allows to report both the name at birth and the name after marriage.

Element	Attribute	Size	Input Type	Requirement
Name	nameType		stf:OECDNameType_Enum_Type	optional

It is possible for STF documents to contain several names for the same party. This attribute is a qualifier to indicate the type of a particular name.

Element	Attribute	Size	Input Type	Requirement
PrecedingTitle		1 to 200 characters	stf:StringMin1Max200_Type	Optional

Element	Attribute	Size	Input Type	Requirement
Title		1 to 200 characters	stf:StringMin1Max200_Type	Optional

Element	Attribute	Size	Input Type	Requirement
FirstName		1 to 200 characters	stf:StringMin1Max200_Type	Validation

This data element is required for identifying individual Sellers in the context of the DPI Schema. If the sending Competent Authority was not provided with a complete first name for an individual, an initial or NFN (“No First Name”) may be used here.

Element	Attribute	Size	Input Type	Requirement
FirstName	xnlNameType	1 to 200 characters	stf:StringMin1Max200_Type	Optional

This attribute can be used to define the meaning of the First Name element, which may vary from one cultural environment to another.

Element	Attribute	Size	Input Type	Requirement
MiddleName		1 to 200 characters	stf:StringMin1Max200_Type	Optional

This data element allows the individual’s Middle Name to be entered. The data is optional.

Element	Attribute	Size	Input Type	Requirement
MiddleName	xnlNameType	1 to 200 characters	stf:StringMin1Max200_Type	Optional

This attribute can be used to define the meaning of the Middle Name element, which may vary from one cultural environment to another.

Element	Attribute	Size	Input Type	Requirement
NamePrefix		1 to 200 characters	stf:StringMin1Max200_Type	Optional

Element	Attribute	Size	Input Type	Requirement
NamePrefix	xnlNameType	1 to 200 characters	stf:StringMin1Max200_Type	Optional

This attribute can be used to define the meaning of the Name Prefix element, which may vary from one cultural environment to another.

Element	Attribute	Size	Input Type	Requirement
LastName		1 to 200 characters	stf:StringMin1Max200_Type	Validation

This data element is required. This field can include any prefix or suffix legally used by the individual Seller.

As the element is a string it is possible to use this for a free format name or two last names although wherever possible the structured first name and last name should be used.

Element	Attribute	Size	Input Type	Requirement
LastName	xnlNameType	1 to 200 characters	stf:StringMin1Max200_Type	Optional

This attribute can be used to define the meaning of the Last Name element, which may vary from one cultural environment to another.

Element	Attribute	Size	Input Type	Requirement
GenerationIdentifier		1 to 200 characters	stf:StringMin1Max200_Type	Optional

Element	Attribute	Size	Input Type	Requirement
Suffix		1 to 200 characters	stf:StringMin1Max200_Type	Optional

Element	Attribute	Size	Input Type	Requirement
GeneralSuffix		1 to 200 characters	stf:StringMin1Max200_Type	Optional

Address (Address_Type)

The Address element is further comprised of the same elements as previously set out in relation to OrganisationParty_Type.

Nationality

Element	Attribute	Size	Input Type	Requirement
Nationality			iso:CountryCode_Type	Optional

The nationality element is not to be provided as part of the DPI schema.

BirthInfo

Element	Attribute	Size	Input Type	Requirement
BirthInfo				Validation

The Birth Info element contains the birth information of an Individual Seller. It is always required to be provided, unless such Seller is documented pursuant to a Government Verification Service, and is composed of:

Element	Attribute	Size	Input Type	Requirement
BirthDate			xsd:date	Validation

This data element is required and identifies the date of birth of the individual Seller. The data format is yyyy-MM-DD.

Element	Attribute	Size	Input Type	Requirement
BirthPlace			Dpi:BirthPlace_Type	Optional

This data element allows to give information on the place of birth of the Individual Seller.

[EU Specific] The place of birth of the Individual Seller must be provided in case no TIN is provided or available on the basis of Article 8ac(2)(d) in [EU DIR2021/514].

BirthPlace (BirthPlace_Type)

This is a datatype for providing information about the place of birth of the Individual Seller. Where the OECD Model Rules or [EU DIR2021/514] require the place of birth to be provided in respect of an Individual Seller, at the minimum the city and country of birth must also be provided.

Element	Attribute	Size	Input Type	Requirement
City		1 to 200 characters	stf:StringMin1Max200_Type	Validation

Element	Attribute	Size	Input Type	Requirement
CitySubentity		1 to 200 characters	stf:StringMin1Max200_Type	Optional

Element	Attribute	Size	Input Type	Requirement
CountryInfo				Validation

This required data element gives a choice between a current jurisdiction (identified by 2-character country code) or a former jurisdiction (identified by name). One or the other should be supplied if place of birth is reported, together with City or City and City Subentity. The Former Country Name element should be used in case the person was born in a country that has since ceased to exist.

Element	Attribute	Size	Input Type	Requirement
CountryCode		2-character	iso:CountryCode_Type	Validation

Element	Attribute	Size	Input Type	Requirement
FormerCountryName		1 to 200 characters	stf:StringMin1Max200_Type	Optional

IV. DPI Body

The DPI Body element contains the information on the Reporting Platform Operator, on the Other Platform Operators as well as on the Relevant Activities performed by Reportable Sellers that give rise to the exchange.

[OECD Specific] The DPI Body should be empty where a Tax Administration 1 reports to another Tax Administration 2 that there are no Reportable Sellers resident in Tax Administration 2 in respect of any of the Reporting Platforms in Tax Administration 1. Otherwise, the DPI Body should be reported.

Element	Attribute	Size	Input Type	Requirement
DPIBody			dpi:DPIBody_Type	Optional (Mandatory)

The DPI Body element is composed of the following three elements:

Element	Attribute	Size	Input Type	Requirement
PlatformOperator			dpi:CorrectablePlatformOperator_Type	Validation

This element contains the identification information on the Reporting Platform Operator, which must be reported pursuant to Subparagraph B(1) of Section III of the OECD Model Rules or [EU Specific] Subparagraph B(1) of Section III of [EU DIR2021/514].

Element	Attribute	Size	Input Type	Requirement
OtherPlatformOperators			dpi:OtherPlatformOperators_Type	Optional (Mandatory)

This element contains the identification information on the assuming or assumed Platform Operators.

Element	Attribute	Size	Input Type	Requirement
ReportableSeller			dpi:CorrectableReportableSeller_Type	Optional (Mandatory)

This element contains the identification information on each Reportable Seller, as well as information on the Relevant Activities provided by such Reportable Seller and the Consideration derived therefrom.

Platform Operator

Element	Attribute	Size	Input Type	Requirement
PlatformOperator			dpi:OrganisationParty_Type	Validation

The Platform Operator element identifies the Reporting Platform Operator and follows the Organisation Party type, as set out above.

Element	Attribute	Size	Input Type	Requirement
DocSpec				stf:DocSpec_Type Validation

DocSpec identifies the particular report within the DPI message being transmitted. It permits the identification of reports requiring correction (for further guidance see the Corrections section below).

Other Platform Operators

Element	Attribute	Size	Input Type	Requirement
OtherPlatformOperators			dpi:OtherPlatformOperators_Type	Optional (Mandatory)

The other Platform Operators element identifies either:

- The Platform Operator assuming the reporting in the name of the Reporting Platform Operator, as identified in the Platform Operator element;
- Each Platform Operator for which the Reporting Platform Operator, as identified in the Platform Operator element, assumes the reporting.

[OECD Specific] This element must be provided, if available.

[EU Specific] This element is optional for the purposes of [EU DIR2021/514].

Element	Attribute	Size	Input Type	Requirement
AssumingPlatformOperator			dpi:CorrectableOtherRPO_Type	Validation (Choice)

This element provides information about the Platform Operator assuming the reporting in the name of the Reporting Platform Operator, as identified in the Platform Operator element. The Assuming Platform Operator element is composed of the following elements:

Element	Attribute	Size	Input Type	Requirement
ResCountryCode		2-character	iso:CountryCode_Type	Optional (Mandatory)

This repeatable data element describes the residence country code(s) of the Platform Operator assuming the reporting. As with the residence country code(s) of the Reporting Platform Operator, the residence country code of the Platform Operator assuming the reporting should correspond to the jurisdiction where

the Platform Operator is resident for tax purposes or, where it does not have a residence for tax purposes, either the jurisdiction it is incorporated under or the jurisdiction that it has its place of management (including effective management) in, [EU Specific] or the Member State where it has a permanent establishment in.

[EU Specific] This element is optional for the purposes of [EU DIR2021/514].

Element	Attribute	Size	Input Type	Requirement
TIN		0 to 200 characters	dpi:TIN_Type	Validation

This repeatable data element follows the TIN Type and provides the tax identification number (TIN) used by the tax administration of the jurisdiction of residence of the Platform Operator assuming the reporting.

Element	Attribute	Size	Input Type	Requirement
Name		1 to 200 characters	dpi:NameOrganisation_Type	Validation

This element must contain the legal name of the Platform Operator assuming the reporting and follows the Name Organisation Type.

Element	Attribute	Size	Input Type	Requirement
Address			dpi:Address_Type	Validation

This data element follows the Address Type and should contain the address of the Platform Operator assuming the reporting.

Element	Attribute	Size	Input Type	Requirement
DocSpec				stf:DocSpec_Type Validation

DocSpec identifies the particular report within the DPI message being transmitted. It permits the identification of reports requiring correction (for further guidance see the Corrections section below).

Element	Attribute	Size	Input Type	Requirement
AssumedPlatformOperator			dpi:CorrectableOtherRPO_Type	Validation (Choice)

This repeatable element provides information about each Platform Operator for which the Reporting Platform Operator, as identified in the Platform Operator element, assumes the reporting. The Assumed PlatformOperator element is composed of the following elements:

Element	Attribute	Size	Input Type	Requirement
ResCountryCode		2-character	diso:CountryCode_Type	Optional (Mandatory)

This repeatable data element describes the residence country code(s) of each Platform Operator for which the Reporting Platform Operator assumes the reporting. As with the residence country code of the Reporting Platform Operator, the residence country code of each Platform Operator for which the Reporting Platform Operator assumes the reporting should correspond to the jurisdiction where the Platform Operator is resident for tax purposes or, where it does not have a residence for tax purposes, either the jurisdiction it is incorporated under or the jurisdiction that it has its place of management (including effective management) in, [EU Specific] or the Member State where it has a permanent establishment in.

[EU Specific] This element is optional for the purposes of [EU DIR2021/514].

Element	Attribute	Size	Input Type	Requirement
TIN		0 to 200 characters	dpi:TIN_Type	Validation

This repeatable data element follows the TIN Type and provides the tax identification number (TIN) used by the tax administration(s) of the jurisdiction(s) of residence of each Platform Operator for which the Reporting Platform Operator assumes the reporting.

Element	Attribute	Size	Input Type	Requirement
Name		1 to 200 characters	dpi:NameOrganisation_Type	Validation

This repeatable data element must contain the legal name of each Platform Operator for which the Reporting Platform Operator assumes the reporting and follows the Name Organisation Type.

Element	Attribute	Size	Input Type	Requirement
Address			dpi:Address_Type	Validation

This repeatable data element follows the Address Type and should contain the address of each Platform Operator for which the Reporting Platform Operator assumes the reporting.

Element	Attribute	Size	Input Type	Requirement
DocSpec				stf:DocSpec_Type Validation

DocSpec identifies the particular report within the DPI message being transmitted. It permits the identification of reports requiring correction (for further guidance see the Corrections section below).

Reportable Seller

Element	Attribute	Size	Input Type	Requirement
Reportable Seller			dpi:CorrectableReportableSeller_Type	Optional (Mandatory)

The correctable and repeatable Reportable Seller element is comprised of the Identity, Relevant Activities and DocSpec elements.

In case of nil reporting, i.e. when MessageTypeId is set to "DPI403", no Reportable Seller must be provided.

Element	Attribute	Size	Input Type	Requirement
Identity				Validation

The Identity element identifies the Reportable Seller subject to exchange under the OECD Model Rules or [\[EU Specific\]](#) [EU DIR2021/514].

Element	Attribute	Size	Input Type	Requirement
RelevantActivities				Validation

The Relevant Activities element includes information on the Relevant Activities provided by such Reportable Seller and the Consideration derived therefrom.

Element	Attribute	Size	Input Type	Requirement
DocSpec				stf:DocSpec_Type Validation

DocSpec identifies the particular report within the DPI message being transmitted. It permits the identification of reports requiring correction (for further guidance see the Corrections section below).

Identity

Element	Attribute	Size	Input Type	Requirement
Identity				Validation

The Identity element is comprised of the Entity Seller and Individual Seller elements, depending on the legal form of the Reportable Seller.

Element	Attribute	Size	Input Type	Requirement
EntitySeller				Validation (Choice)

The Entity Seller element should be completed in case the Reportable Seller is an entity.

Element	Attribute	Size	Input Type	Requirement
IndividualSeller				Validation (Choice)

The Individual Seller element should be completed in case the Reportable Seller is an individual.

Entity Seller

Element	Attribute	Size	Input Type	Requirement
EntitySeller				Validation

The Entity Seller element is comprised of the Standard and GVS elements, reflecting the two types of due diligence procedures a Reportable Platform Operator may rely upon to determine the identity and tax residence of an Entity Seller.

Element	Attribute	Size	Input Type	Requirement
Standard				Validation (Choice)

The Standard element should be completed in case the Reporting Platform Operator has relied on the standard due diligence procedures of the OECD Model Rules or [\[EU Specific\]](#) [EU DIR2021/514] to identify and document the Entity Seller.

Element	Attribute	Size	Input Type	Requirement
GVS			dpi:GVSType	Validation (Choice)

The GVS element should be completed in case the Reporting Platform Operator has relied on an approved Government Verification Service in order to identify and document the Entity Seller.

Entity Seller: Standard

Element	Attribute	Size	Input Type	Requirement
Standard				Validation

The Standard element reflects the information subject to reporting and exchange where a Reporting Platform Operator relied on the standard (non-GVS) due diligence procedures to determine the identity and tax residence of an Entity Seller. The element is comprised of the EntSellerID and FinancialIdentifier elements. Platform Operators by default would use the standard due diligence procedures, but can also rely on the GVS procedure where it has been made available by the Reportable Jurisdiction.

Element	Attribute	Size	Input Type	Requirement
EntSellerID			dpi:OrganisationParty_Type	Validation

The EntSellerID element identifies the Entity Seller and follows the Organisation Party type, as set out above.

Element	Attribute	Size	Input Type	Requirement
FinancialIdentifier			dpi:FinancialIdentifier_Type	Optional (Mandatory)

The Financial Identifier is an optional (mandatory) and repeatable element that reflects the Financial Account Identifier which, under the OECD Model Rules or [\[EU Specific\]](#) [EU DIR2021/514], is the unique

identifying number or reference available to the Reporting Platform Operator of the bank account or other payment account to which the Consideration is paid or credited. Under subparagraphs B(2)(c) and B(3)(c) of Section III of the OECD Model Rules or [EU Specific] subparagraphs B(2)(b) and B(3)(b) of Section III of [EU DIR2021/514], the Financial Identifier must be reported and exchanged provided that it is available to the Reporting Platform Operator and that the jurisdiction of the Reportable Seller's residence has indicated that it wishes to receive such Financial Identifiers for taxpayer matching purposes. The Financial Identifier element is comprised of the Identifier, Name and OtherInfo elements.

Element	Attribute	Size	Input Type	Requirement
Identifier		1 to 200 characters	dpi:Identifier_Type	Validation

The Identifier field is a required element which contains the Financial Account Identifier pertaining to the Reportable Seller should be reflected. Financial Account Identifiers can include the IBAN number, sort code and account number and any other payment account identifier that the Reporting Platform Operator used for transferring the Consideration in respect to a Reportable Seller.

Element	Attribute	Size	Input Type	Requirement
Identifier	AccountNumberType	1 to 200 characters	stf:StringMin1Max200_Type	Optional (Mandatory)

The attribute describes the type of account number being sent.

Element	Attribute	Size	Input Type	Requirement
AccountHolderName		1 to 200 characters	stf:StringMin1Max200_Type	Optional (Mandatory)

The Account Holder Name field is an optional (mandatory) element which, reflecting subparagraphs B(2)(d) and B(3)(d) of Section III of the OECD Model Rules or [EU Specific] subparagraphs B(2)(c) and B(3)(c) of Section III of [EU DIR2021/514], contains the name of the holder of the financial account to which the Consideration is paid or credited, where different from the name of the Reportable Seller and to the extent available to the Reporting Platform Operator.

Element	Attribute	Size	Input Type	Requirement
OtherInfo		1 to 400 characters	stf:StringMin1Max400_Type	Optional (Mandatory)

Reflecting subparagraphs B(2)(d) and B(3)(d) of Section III of the OECD Model Rules or [EU Specific] subparagraphs B(2)(c) and B(3)(c) of Section III of [EU DIR2021/514], the OtherInfo field contains any other identifying information available to the Reporting Platform Operator with respect to that account holder.

Element	Attribute	Size	Input Type	Requirement
PermanentEstablishments			Dpi:PermanentEstablishments_Type	Optional (Mandatory)

[EU Specific] This data element provides information on any permanent establishment through which Relevant Activities are carried out by the Entity Seller in the Union, indicating each respective EU Member State where such a permanent establishment is located.

Element	Attribute	Size	Input Type	Requirement
PermanentEstablishment		2-character	iso:MSCountryCode_Type	Validation

The repeatable Permanent Establishment element identifies an EU Member State where a permanent establishment through which Relevant Activities are carried out by the Entity Seller in the Union is located.

Entity Seller: GVS

Element	Attribute	Size	Input Type	Requirement
GVS			dpi:GVSType	Validation

The GVS element reflects the Government Verification Service (GVS) due diligence procedures under the OECD Model Rules and is composed of the Name GVS, Jurisdiction GVS, Reference GVS and Other TIN GVS elements, which contain the information items subject to reporting (and exchange) in respect of an Entity Seller that has been identified on the basis of a Government Verification Service, as well as the Financial Identifier element.^[EU Specific] At the time of publication, the collection and exchange of GVS information is not a legal requirement under [EU DIR2021/514].

Element	Attribute	Size	Input Type	Requirement
NameGVS		1 to 200 characters	stf:StringMin1Max200_Type	Validation

The Name GVS element contains the legal name of the Entity Seller.

Element	Attribute	Size	Input Type	Requirement
JurisdictionGVS		2-character	iso:CountryCode_Type	Validation

The Jurisdiction GVS element identifies the jurisdiction whose Government Verification Service was relied upon by the Reporting Platform Operator in respect of the Entity Seller.

It uses the 2-character alphabetic country code and country name list⁵ based on the ISO 3166-1 Alpha 2 standard.

Element	Attribute	Size	Input Type	Requirement
ReferenceGVS		1 to 200 characters	stf:StringMin1Max200_Type	Validation

The Reference GVS element contains the unique reference number or code provided by the jurisdiction whose GVS was used, allowing that jurisdiction to match the Entity Seller to a taxpayer within its database.

Element	Attribute	Size	Input Type	Requirement
OtherTINGVS		1 to 200 characters	stf:StringMin1Max200_Type	Optional

Reflecting subparagraph B(2)(b) and B(3)(b) of Section III of the OECD Model Rules, the Other TIN GVS element contains any TIN available to the Reporting Platform Operator, including the jurisdiction of issuance.

Element	Attribute	Size	Input Type	Requirement
FinancialIdentifier			dpi:FinancialIdentifier_Type	Optional (Mandatory)

The Financial Identifier element follows the structure set out above.

Individual Seller

Element	Attribute	Size	Input Type	Requirement
IndividualSeller				Validation

The Individual Seller element is comprised of the Standard and GVS elements, reflecting the two types of due diligence procedures a Reportable Platform Operator may rely upon to determine the identity and tax residence of an individual Seller.

Element	Attribute	Size	Input Type	Requirement
Standard				Validation (Choice)

⁵ The following disclaimer refers to all uses of the ISO country code list in the Digital Platforms Schema. For practical reasons, the list is based on the ISO 3166-1 country list. The use of this list does not imply the expression by the OECD of any opinion whatsoever concerning the legal status of the territories listed. Its content is without prejudice to the status of or sovereignty over any territory, to the delimitation of international frontiers and boundaries and to the name of any territory, city or area.

The Standard element should be completed in case the Reporting Platform Operator has relied on the standard due diligence procedures of the OECD Model Rules or [\[EU Specific\]](#) [EU DIR2021/514] to identify and document the individual Seller.

Element	Attribute	Size	Input Type	Requirement
GVS			dpi:GVSType	Validation (Choice)

The GVS element should be completed in case the Reporting Platform Operator has relied on an approved Government Verification Service in order to identify and document the individual Seller.

Individual Seller: Standard

Element	Attribute	Size	Input Type	Requirement
Standard				Validation

The Standard element reflects the information subject to reporting and exchange where a Reporting Platform Operator relied on the standard (non-GVS) due diligence procedures to determine the identity and residence of an individual Seller. The element is further comprised of the IndSellerID element and the Financial Identifier element. Platform Operators by default would use the standard due diligence procedures, but can also rely on the GVS procedure where it has been made available by the Reportable Jurisdiction.

Element	Attribute	Size	Input Type	Requirement
IndSellerID			dpi:PersonParty_Type	Validation

The IndSellerID element identifies the individual Seller and follows the Person Party Type, as set out above.

Element	Attribute	Size	Input Type	Requirement
FinancialIdentifier			dpi:FinancialIdentifier_Type	Optional (Mandatory)

The Financial Identifier element is further comprised of the Identifier, Account Holder Name and Other Info elements, as previously set out in relation to Entity Sellers.

IndividualSeller: GVS

Element	Attribute	Size	Input Type	Requirement
GVS			dpi:GVSType	Validation

The GVS element follows the same structure and sub-elements as set out for Entity Sellers above, therewith reflecting the GVS due diligence procedures under the OECD Model Rules, where Entity Seller must be read as Individual Seller [\[EU Specific\]](#) At the time of publication, the collection and exchange of GVS information is not a legal requirement under [EU DIR2021/514].

Relevant Activities

Element	Attribute	Size	Input Type	Requirement
RelevantActivities				Validation

The Relevant Activities element includes information on the Relevant Activities provided by Reportable Sellers and the Consideration derived therefrom. The element is comprised of the Immovable Property, Personal Services, sale of Goods and Transportation Rental elements, reflecting the nature of the activities provided by the Reportable Seller. Under the OECD Model Rules and [EU DIR2021/514], information in respect of the Immovable Property and Personal Services elements must be provided. Under the OECD

Extended Scope and [EU DIR2021/514], information in respect of the sale of Goods and Transportation Rental elements must also be provided.

Element	Attribute	Size	Input Type	Requirement
ImmovableProperty				Optional (Mandatory)

The Immovable Property element specifies the Relevant Activities provided by a Reportable Seller with respect to the rental of immovable property.

Element	Attribute	Size	Input Type	Requirement
PersonalServices			dpi:OtherActivities_Type	Optional (Mandatory)

The Personal Services element specifies the Relevant Activities provided by a Reportable Seller that are Personal Services, as defined in the OECD Model Rules or [EU Specific] [EU DIR2021/514].

Element	Attribute	Size	Input Type	Requirement
SaleOfGoods			dpi:OtherActivities_Type	Optional (Mandatory)

The Sale of Goods element specifies the Relevant Activities provided by a Reportable Seller with respect to sale of goods.

Element	Attribute	Size	Input Type	Requirement
TransportationRental			dpi:OtherActivities_Type	Optional (Mandatory)

The Transportation Rental element specifies the Relevant Activities provided by a Reportable Seller with respect to the rental of any mode of transport.

In the context of the Relevant Activities element the following Types are used throughout:

Consideration Type

Element	Attribute	Size	Input Type	Requirement
Consideration			dpi:ConsiderationType	Validation

The Consideration element contains information on the Consideration received by a Reportable Seller in relation to the Relevant Activities provided. It is further split into four elements, representing the quarters during which the Consideration was paid or credited to a Reportable Seller. In this respect, Consideration is considered to be paid or credited to a Reportable Seller when it is paid or credited to an account specified by the Reportable Seller (as stated in paragraph 32 of the Commentary to Section I of the OECD Model Rules).

For Relevant Activities involving the rental of immovable property, the Consideration information must be provided separately with respect to each Property Listing.

Element	Attribute	Size	Input Type	Requirement
ConsQ1			dpi:MonAmnt_Type	Validation

This element contains information on the Consideration received by a Reportable Seller in the first quarter.

Element	Attribute	Size	Input Type	Requirement
ConsQ2			dpi:MonAmnt_Type	Validation

This element contains information on the Consideration received by a Reportable Seller in the second quarter.

Element	Attribute	Size	Input Type	Requirement
ConsQ3			dpi:MonAmnt_Type	Validation

This element contains information on the Consideration received by a Reportable Seller in the third quarter.

Element	Attribute	Size	Input Type	Requirement
ConsQ4			Input Type	Requirement
			Input Type	Requirement

This element contains information on the Consideration received by a Reportable Seller in the fourth quarter.

Element	Attribute	Size	Input Type	Requirement
ConsQ1	currCode	3 characters	iso:currCode_Type	Validation
ConsQ2	currCode	3 characters	iso:currCode_Type	Validation
ConsQ3	currCode	3 characters	iso:currCode_Type	Validation
ConsQ4	currCode	3 characters	iso:currCode_Type	Validation

Each quarter element is further comprised of the MonAmnt_Type, used to communicate the monetary amounts paid or credited to Reportable Sellers. Such amounts shall be given in full units, i.e. without decimals. The code for the currency, in which the value is expressed has to be taken from the ISO code list 4217 and added in attribute currCode.

Number of Activities Type

Element	Attribute	Size	Input Type	Requirement
NumberOfActivities			Input Type	Requirement
			Input Type	Requirement

The Number of Activities element specified the number of Relevant Activities that a Reportable Seller has provided. It is further split into four elements. Pursuant to subparagraphs B(2)(f) and B(3)(g) of Section III of the OECD Model Rules or [EU Specific] subparagraphs B(2)(e) and B(3)(f) of Section III of [EU DIR2021/514], these elements represent the four quarters in respect of which reporting of the number of Relevant Activities in respect of which Consideration was paid or credited to the Reportable Seller is required. As such, that the numbers of activities are reported on the basis of the date of payment or credit of the Consideration.

For Relevant Activities involving the rental of immovable property, the number of activities must be provided separately with respect to each Property Listing.

Element	Attribute	Size	Input Type	Requirement
NumbQ1			xsd:integer	Validation

This element contains information on the number of Relevant Activities provided by a Reportable Seller in the first quarter.

Element	Attribute	Size	Input Type	Requirement
NumbQ2			xsd:integer	Validation

This element contains information on the number of Relevant Activities provided by a Reportable Seller in the second quarter.

Element	Attribute	Size	Input Type	Requirement
NumbQ3			xsd:integer	Validation

This element contains information on the number of Relevant Activities provided by a Reportable Seller in the third quarter.

Element	Attribute	Size	Input Type	Requirement
NumbQ4			xsd:integer	Validation

This element contains information on the number of Relevant Activities provided by a Reportable Seller in the fourth quarter.

Fees Type

Element	Attribute	Size	Input Type	Requirement
Fees			Input Type	Requirement

The Fees element specifies the fees and commissions that a Reporting Platform Operator has withheld in respect of a Reportable Seller. It is split into four elements, representing the quarters in respect of which the reporting of fees or commissions withheld or charged by the Reporting Platform Operator is required under subparagraphs B(2)(g) and B(3)(h) of Section III of the OECD Model Rules or [\[EU Specific\]](#) subparagraphs B(2)(f) and B(3)(g) of Section III of [\[EU DIR2021/514\]](#).

Element	Attribute	Size	Input Type	Requirement
FeesQ1			Input Type	Requirement

This element contains information on the fees and commissions withheld in respect of a Reportable Seller in the first quarter.

Element	Attribute	Size	Input Type	Requirement
FeesQ2			Input Type	Requirement

This element contains information on the fees and commissions withheld in respect of a Reportable Seller in the second quarter.

Element	Attribute	Size	Input Type	Requirement
FeesQ3			Input Type	Requirement

This element contains information on the fees and commissions withheld in respect of a Reportable Seller in the third quarter.

Element	Attribute	Size	Input Type	Requirement
FeesQ4			Input Type	Requirement

This element contains information on the fees and commissions withheld in respect of a Reportable Seller in the fourth quarter.

Note that in case no fees and no commissions are paid in a quarter, the value of the respective element will be set to zero.

Element	Attribute	Size	Input Type	Requirement
FeesQ1	currCode	3 characters	Input Type	Requirement
FeesQ2	currCode	3 characters	Input Type	Requirement
FeesQ3	currCode	3 characters	Input Type	Requirement
FeesQ4	currCode	3 characters	Input Type	Requirement

Each quarter element is further comprised of the MonAmnt_Type, used to communicate the fees withheld or charged by the Reporting Platform Operator. Such amounts shall be given in full units, i.e. without decimals. The code for the currency, in which the value is expressed has to be taken from the ISO code list 4217 and added in attribute currCode.

Taxes Type

Element	Attribute	Size	Input Type	Requirement
Taxes			Input Type	Requirement

The Taxes element specifies the taxes that a Reporting Platform Operator has withheld in respect of a Reportable Seller. It is further split into four elements, representing the quarters in respect of which reporting of taxes withheld by the Reporting Platform Operator is required under subparagraphs B(2)(g)

and B(3)(h) of Section III of the OECD Model Rules or [EU Specific] subparagraphs B(2)(f) and B(3)(g) of Section III of [EU DIR2021/514].

Element	Attribute	Size	Input Type	Requirement
TaxQ1			Input Type	Validation

This element contains information on the taxes withheld in respect of a Reportable Seller in the first quarter.

Element	Attribute	Size	Input Type	Requirement
TaxQ2			Input Type	Validation

This element contains information on the taxes withheld in respect of a Reportable Seller in the second quarter.

Element	Attribute	Size	Input Type	Requirement
TaxQ3			Input Type	Validation

This element contains information on the taxes withheld in respect of a Reportable Seller in the third quarter.

Element	Attribute	Size	Input Type	Requirement
TaxQ4			Input Type	Validation

This element contains information on the taxes withheld in respect of a Reportable Seller in the fourth quarter.

Note that in case no taxes have been paid in a quarter, the value of the respective element will be set to zero.

Element	Attribute	Size	Input Type	Requirement
TaxQ1	currCode	3 characters	Input Type	Validation
TaxQ2	currCode	3 characters	Input Type	Validation
TaxQ3	currCode	3 characters	Input Type	Validation
TaxQ4	currCode	3 characters	Input Type	Validation

Each quarter element is further comprised of the MonAmnt_Type, used to communicate taxes withheld in respect of Sellers. Such amounts shall be given in full units, i.e. without decimals. The code for the currency, in which the value is expressed has to be taken from the ISO code list 4217 and added in attribute currCode.

Immovable Property

Element	Attribute	Size	Input Type	Requirement
ImmovableProperty			Input Type	Optional (Mandatory)

The Immovable Property element contains information on Relevant Activities provided by a Reportable Seller in relation to the rental of immovable property. It comprises the repeatable Property Listing element.

Property Listing

Element	Attribute	Size	Input Type	Requirement
PropertyListing			Input Type	Validation

Acknowledging that a single Reportable Seller may rent more than one property listing, the Property Listing element is repeatable and should be repeated for each property in relation to which a Reportable Seller has received Consideration.

The Property Listing element is comprised of the Address, Land Registration Number, Consideration, Number of Activities, Fees, Taxes, Property Type and Rented days elements.

Element	Attribute	Size	Input Type	Requirement
Address			dpi:Address_Type	Validation

The Address element is further comprised of the elements as described above under the Address Type.

Element	Attribute	Size	Input Type	Requirement
LandRegistrationNumber		1 to 200 characters	stf:StringMin1Max200_Type	Optional (Mandatory)

The Land Registration Number element contains the land registration number, which under subparagraph B(3)(f) of Section III of the OECD Model Rules or [EU Specific] subparagraph B(3)(e) of Section III of [EU DIR2021/514], is reportable if available to the Reporting Platform Operator. For these purposes, the land registration number includes functional equivalents, such as a cadastral number.

Element	Attribute	Size	Input Type	Requirement
Consideration			dpi:ConsiderationType	Validation

The Consideration element follows the Consideration Type described above.

Element	Attribute	Size	Input Type	Requirement
NumberOfActivities			dpi:NumberOfActivities_Type	Validation

The Number of Activities element follows the Number of Activities Type described above.

Element	Attribute	Size	Input Type	Requirement
Fees			dpi:FeesType	Validation

The Fees element follows the Fees Type described above.

Element	Attribute	Size	Input Type	Requirement
Taxes			dpi:TaxesType	Validation

The Taxes element follows the Taxes Type described above.

Element	Attribute	Size	Input Type	Requirement
PropertyType			dpi:DPIPropertyType_EnumType	Optional (Mandatory)

The Property Type element, pursuant to subparagraph B(3)(i) of Section III of the OECD Model Rules or [EU Specific] [EU DIR2021/514], specifies the type of property rented by the Reportable Seller. The possible values are:

- DPI901: Office
- DPI902: Hotel room
- DPI903: Bed & Breakfast room
- DPI904: House
- DPI905: Apartment
- DPI906: Mobile home
- DPI907: Campground
- DPI908: Boat
- DPI909: Parking space
- DPI910: Other

Element	Attribute	Size	Input Type	Requirement
OtherPropertyType		1 to 200 characters	stf:StringMin1Max200_Type	Optional (Mandatory)

This element describes the type of property in case “DPI910” is selected as Property Type. This element cannot be used in case another Property Type is selected.

Element	Attribute	Size	Input Type	Requirement
Rented Days		Four digits	xsd:integer	Optional (Mandatory)

The Rented Days element, pursuant to subparagraph B(3)(i) of Section III of the OECD Model Rules or [EU Specific] subparagraph B(3)(h) of Section III of [EU DIR2021/514], contains the number of days that the Property Listing was rented during the Reportable Period.

Personal Services

Element	Attribute	Size	Input Type	Requirement
PersonalServices			dpi:OtherActivities_Type	Optional (Mandatory)

The Personal Services element contains information on Relevant Activities involving time- or task-based work performed by one or more individuals, acting either independently or on behalf of an Entity, and which is carried out at the request of a user, either online or physically offline after having been facilitated via Platform.

Element	Attribute	Size	Input Type	Requirement
Consideration			dpi:ConsiderationType	Validation

The Consideration element follows the Consideration Type described above.

Element	Attribute	Size	Input Type	Requirement
NumberOfActivities			dpi:NumberOfActivities_Type	Validation

The Number of Activities element follows the Number of Activities Type described above.

Element	Attribute	Size	Input Type	Requirement
Fees			dpi:FeesType	Validation

The Fees element follows the Fees Type described above.

Element	Attribute	Size	Input Type	Requirement
Taxes			dpi:TaxesType	Validation

The Taxes element follows the Taxes Type described above.

Sale of Goods

Element	Attribute	Size	Input Type	Requirement
SaleOfGoods			dpi:OtherActivities_Type	Optional (Mandatory)

The sale of Goods element specifies the Relevant Activities provided by a Reportable Seller with respect to sale of goods.

Element	Attribute	Size	Input Type	Requirement
Consideration			dpi:ConsiderationType	Validation

The Consideration element follows the Consideration Type described above.

Element	Attribute	Size	Input Type	Requirement
NumberOfActivities			dpi:NumberOfActivities_Type	Validation

The Number of Activities element follows the Number of Activities Type described above.

Element	Attribute	Size	Input Type	Requirement
Fees			dpi:FeesType	Validation

The Fees element follows the Fees Type described above.

Element	Attribute	Size	Input Type	Requirement
Taxes			dpi:TaxesType	Validation

The Taxes element follows the Taxes Type described above.

Transportation Rental

Element	Attribute	Size	Input Type	Requirement
TransportationRental			dpi:OtherActivities_Type	Optional (Mandatory)

The TransportationRental element specifies the Relevant Activities provided by a Reportable Seller with respect to the rental of any mode of transport.

Element	Attribute	Size	Input Type	Requirement
Consideration			dpi:ConsiderationType	Validation

The Consideration element follows the Consideration Type described above.

Element	Attribute	Size	Input Type	Requirement
NumberOfActivities			dpi:NumberOfActivities_Type	Validation

The Number of Activities element follows the Number of Activities Type described above.

Element	Attribute	Size	Input Type	Requirement
Fees			dpi:FeesType	Validation

The Fees element follows the Fees Type described above.

Element	Attribute	Size	Input Type	Requirement
Taxes			dpi:TaxesType	Validation

The Taxes element follows the Taxes Type described above.

Corrections

Introduction

In case the sending jurisdiction becomes aware of inaccurate information, be it in relation to the Platform Operator, the assuming Platform Operator, one or more assumed Platform Operator(s), or in relation to the reporting in respect of one or more Reportable Sellers, a correction will need to be made. As long as the error is discovered prior to the exchange of the schema for a given fiscal year, no correction, as set out in this section, would be required.

However, in case an error is discovered after the exchange of the schema, adjustments to part of the schema will need to be made, in accordance with the guidance set out in this section.

In order to facilitate a targeted reporting of corrections, the DPI XML Schema has four correctable types called Platform Operator, Assuming Platform Operator, Assumed Platform Operator and Reportable Seller.

Technical Guidance

This section describes how to make automatic corrections by sending a file of corrected data that can be processed in the same systems as the original data that was received. Reference to corrections in this section also includes deletion of records.

In order to identify the elements to correct, the correctable elements Platform Operator, Assuming Platform Operator, Assumed Platform Operator and Reportable Seller include an element of the DocSpec_Type, which contains the necessary information for corrections.

DocSpec Type

Element	Attribute	Size	Input Type	Requirement
DocSpec			dpi:DocSpec_Type	Validation

DocSpec identifies the particular record within the DPI message being transmitted. It permits the identification of records requiring correction. The DocSpec element is composed of the following:

Element	Attribute	Size	Input Type	Requirement
DocTypeIndic			dpi:OECDDocTypeIndic_EnumType	Validation

A message can either contain new records (OECD1) or corrections and/or deletions (OECD2 and OECD3), but should not contain a mixture of both. The resend option (OECD0) can only be used for the Platform Operator element when the Platform Operator element has already been sent. The resend option (OECD0) can be used in the two following cases:

- a) New data: in case new Reportable Seller information and/or Other Platform Operator information is provided in respect of a Reportable Period and the Platform Operator element has already been sent.

- b) Correction/deletion: in case the Reportable Seller and/or Other Platform Operator element is corrected (or deleted) and the Platform Operator element has already been sent and the Platform Operator element does not need to be corrected (or deleted). The Platform Operator cannot be deleted without deleting all related Reportable Seller information and Other Platform Operator information (either in same message or in previous messages).

This element specifies the type of data being submitted.

Allowable entries are:

- OECD0 = Resent Data
- OECD1 = New Data
- OECD2 = Corrected Data
- OECD3 = Deletion of Data
- OECD10 = Resent Test Data
- OECD11 = New Test Data
- OECD12 = Corrected Test Data
- OECD13 = Deletion of Test Data

The codes OECD10 through OECD13 must only be used during agreed testing periods or on the basis of a bilateral agreement on testing. This is to ensure that the Competent Authorities avoid test data becoming mingled with 'live' data.

Element	Attribute	Size	Input Type	Requirement
DocRefID		1 to 200 characters	dpi:StringMin1Max200_Type	Validation

The DocRefID is a unique identifier for the document (i.e. one record and all its children data elements). An element containing a correction (or deletion) must have a new unique DocRefID for future reference.

Element	Attribute	Size	Input Type	Requirement
CorrMessageRefID		1 to 170 characters	dpi:StringMin1Max170_Type	Optional

This element must not be used.

Element	Attribute	Size	Input Type	Requirement
CorrDocRefID		1 to 200 characters	dpi:StringMin1Max200_Type	Optional

The CorrDocRefID references the DocRefID of the element to be corrected or deleted. It must always refer to the latest reference of the record (DocRefID) that was sent.

The latest reference of the record (DocRefID) that was sent must be part of the latest message in which the record was sent.

In this way, a series of corrections or amendments can be handled as each correction completely replaces the previous version.

Uniqueness of MessageRefID and DocRefID

In order to ensure that a message and a record can be identified and corrected, the MessageRefID and DocRefID must be unique in space and time (i.e. there must be no other message or record in existence that has the same reference identifier).

The MessageRefID identifier can contain whatever information the sender uses to allow identification of the particular message but must start with the country code of the sending jurisdiction, then the year of the reportable period, then the receiving country code before a unique identifier.

e.g. CA2023LU123456789

This MessageRefID indicates that the Canada is the country of the sending Competent Authority, the receiving Competent Authority is Luxembourg and that the unique identifier is “123456789”.

The unique identifier in the DocRefID is used by the sending Competent Authority to identify a unique DPI record and is composed of the country code of the sending jurisdiction, then the year of the reportable period, followed by a unique identifier.

e.g. CA2023286abc123xyz

This DocRefID indicates that Canada is the sending country and the unique identifier is “286abc123xyz”.

MessageSpec, Corrections and Cancellations

Correction messages must have their own unique MessageRefID so they can also be corrected in the future. There is no equivalent for the DocSpec type when it comes to messages as a whole.

To cancel a complete message, there is no element in the MessageSpec which can be used for that purpose. Instead, a correction message should be sent deleting all records of the erroneous message in these instances.

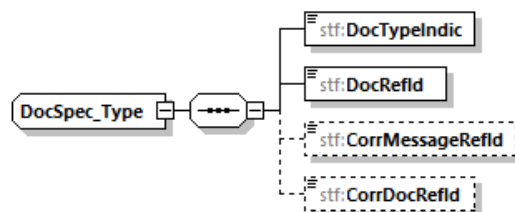

When correcting a record, we will always correct the whole DPI Body record (with all its sub-elements).

Annex 1.A. DPI XML Schema v. 1.0 Diagrams

DPI Schema

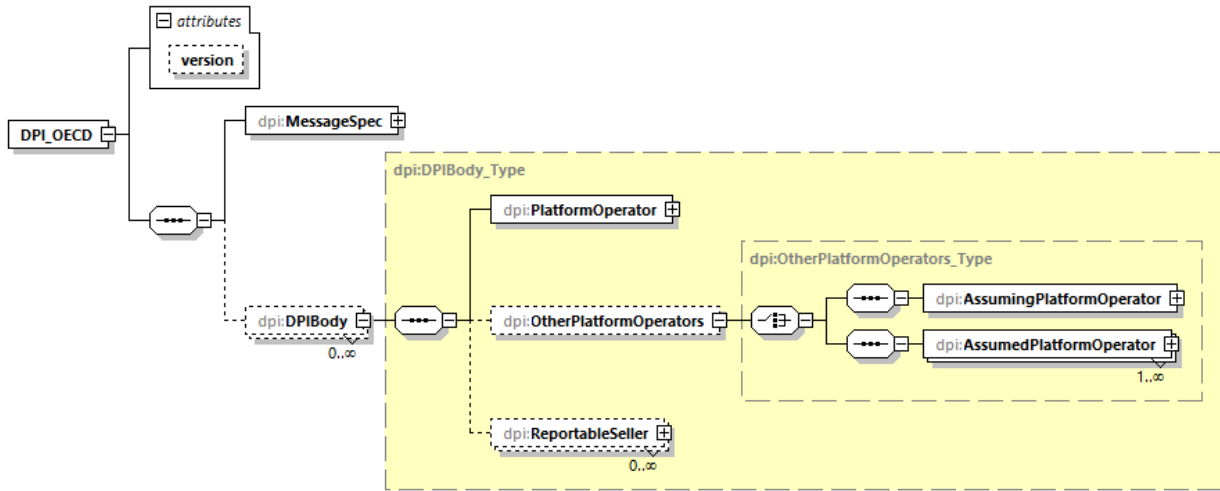

DPI Body

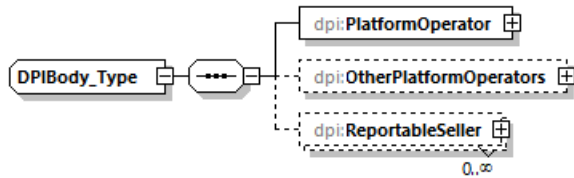

Platform Operator

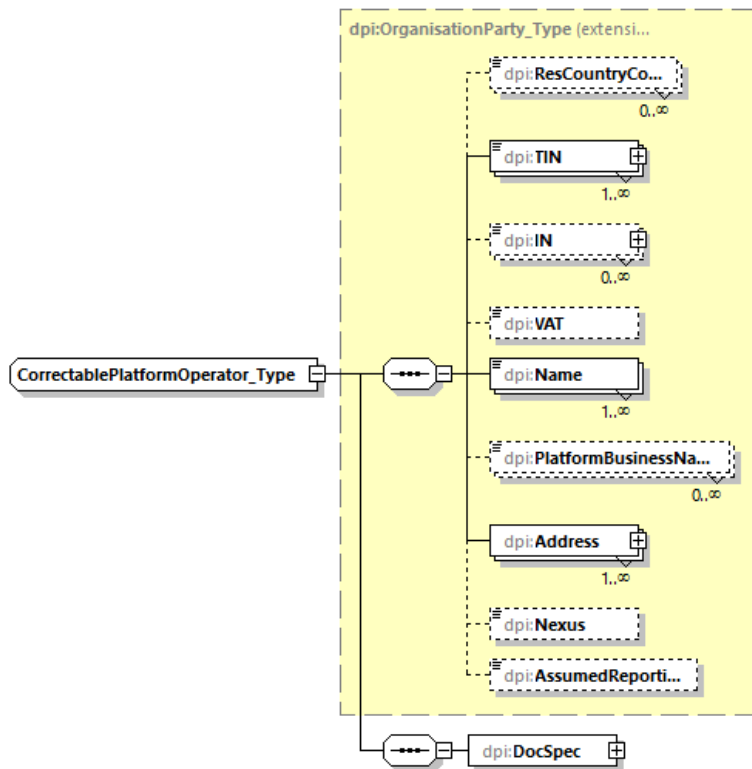

Other Platform Operators

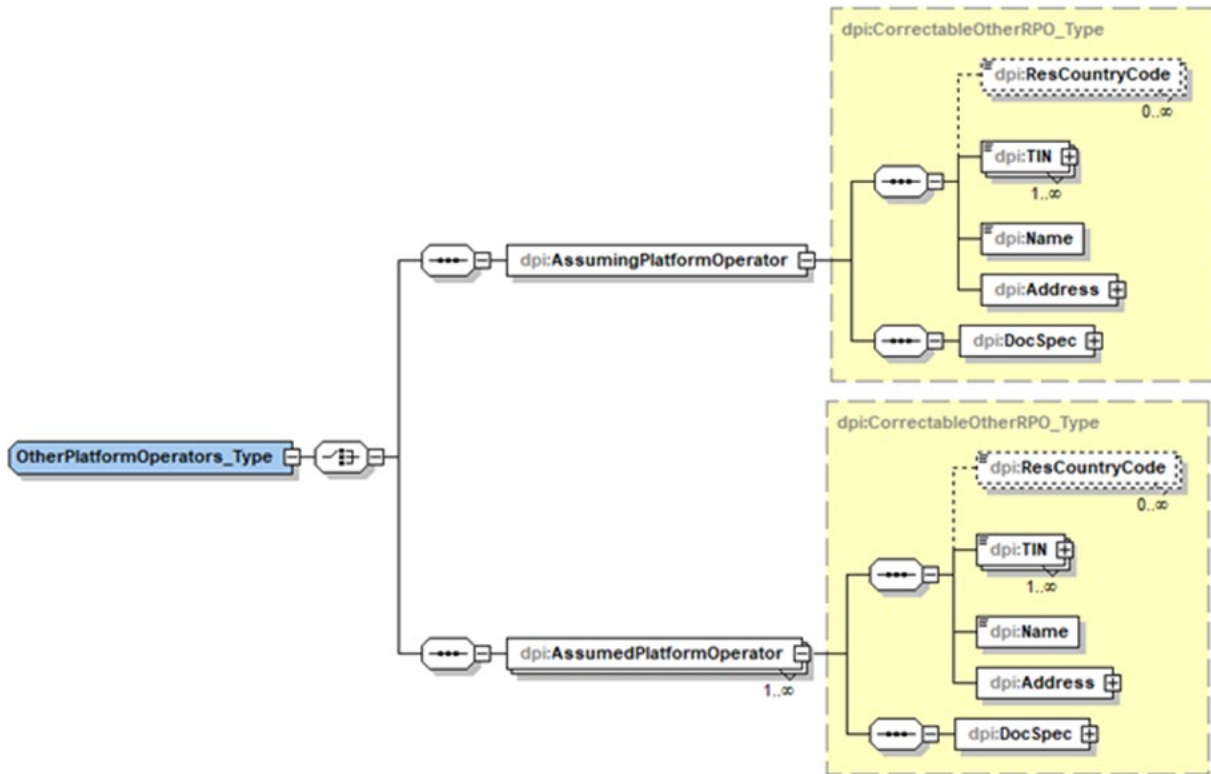

Reportable Seller

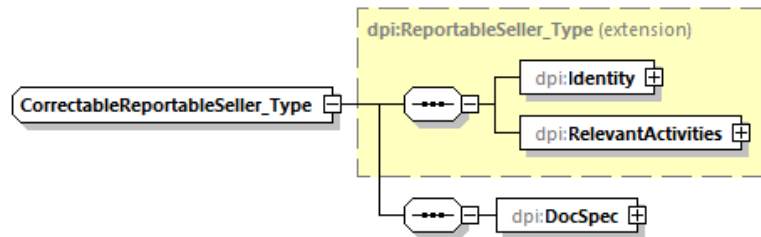

Identity

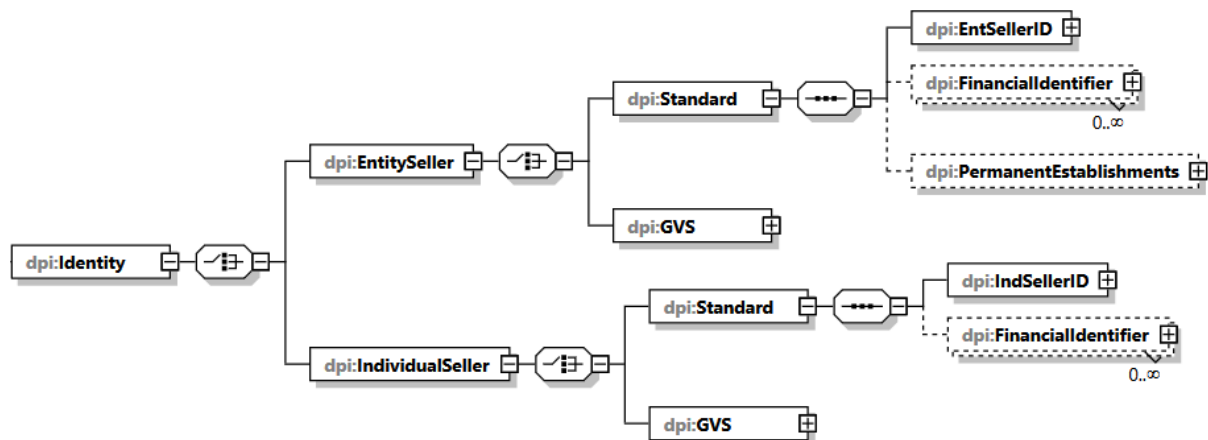

RelevantActivities

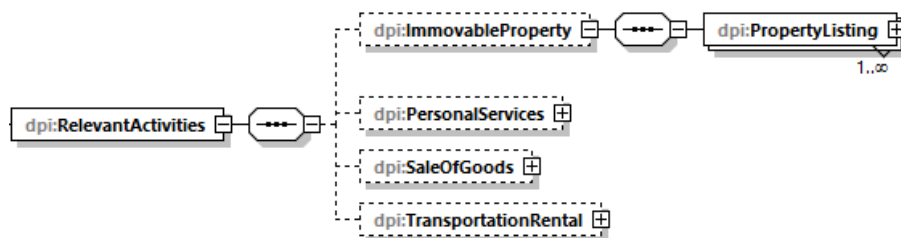

Property Listing

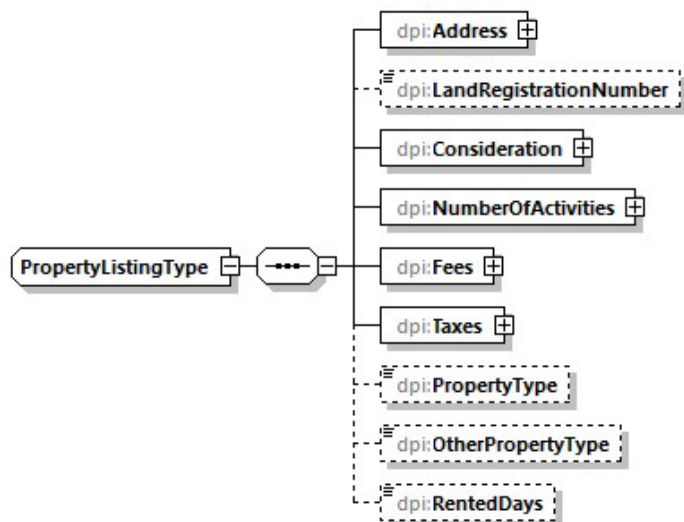

Other Activities

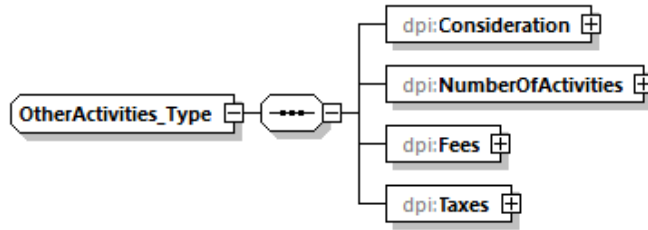

Address

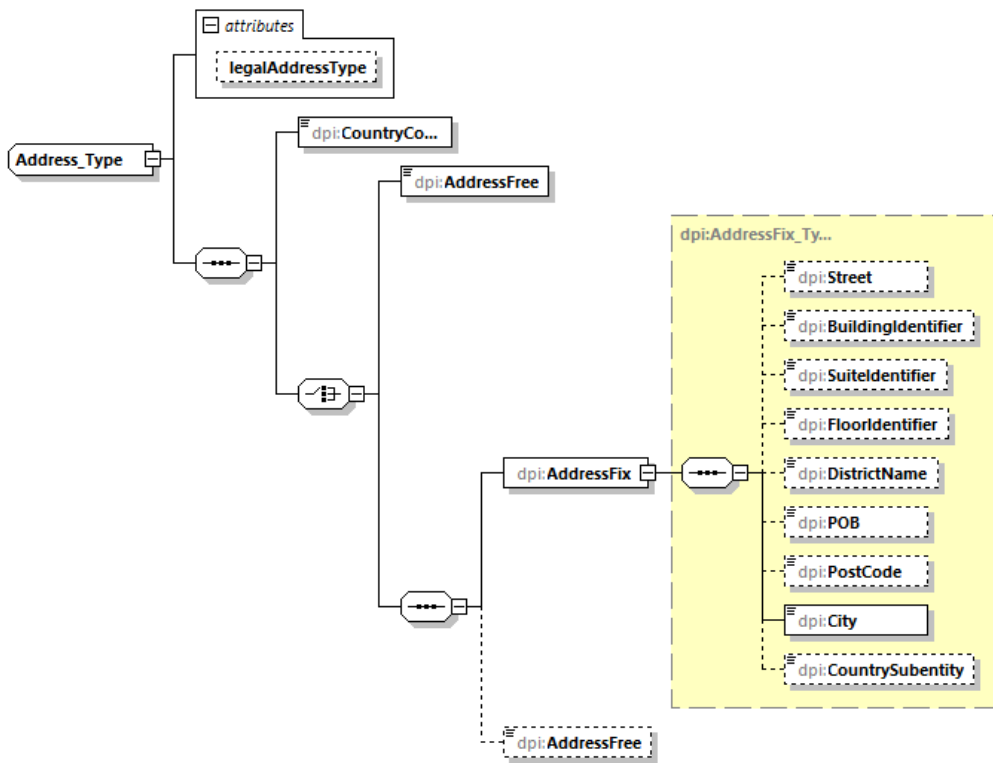

Consideration

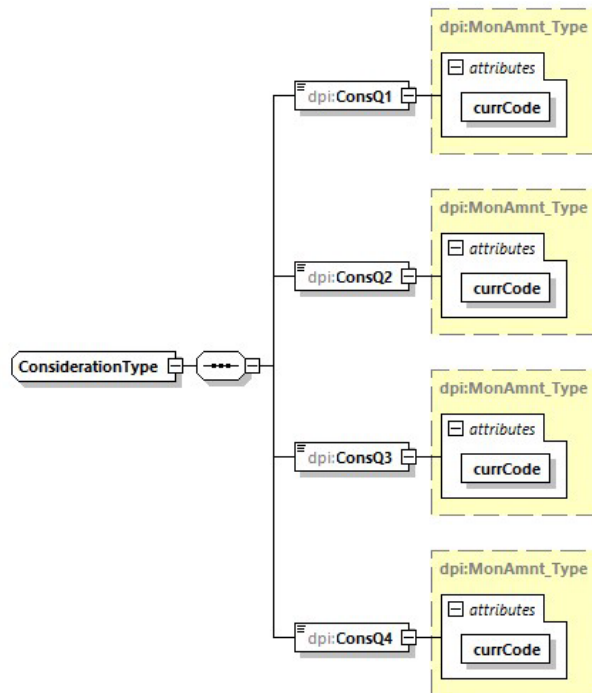

Fees

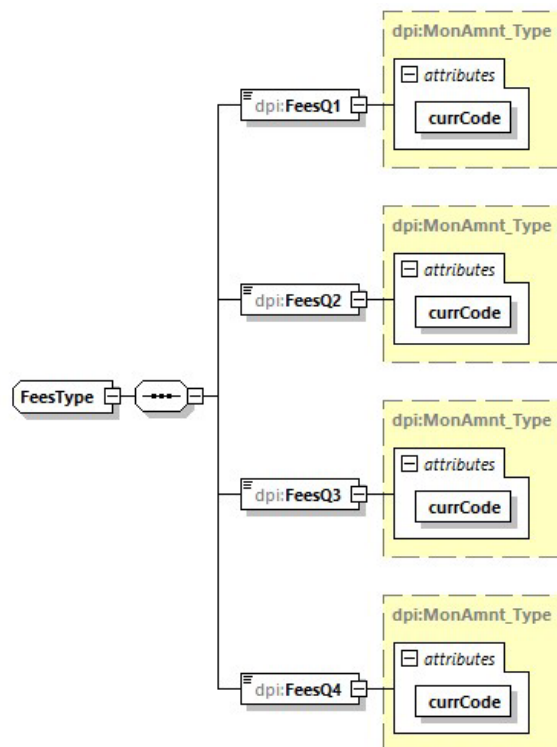

Taxes

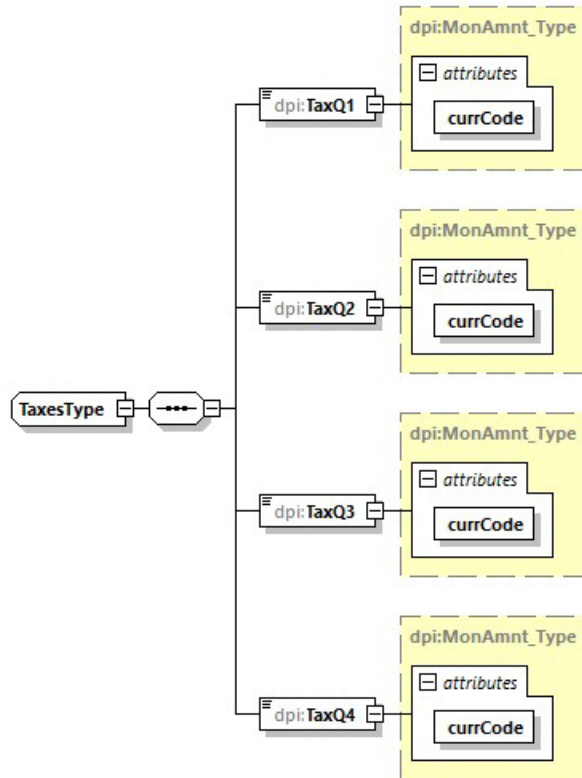

DocSpec

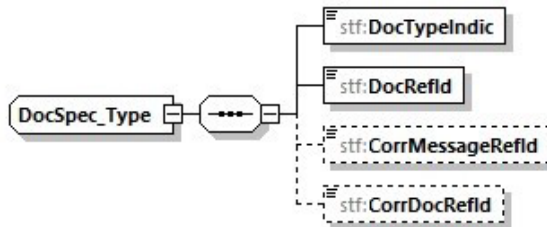

Financial Identifier

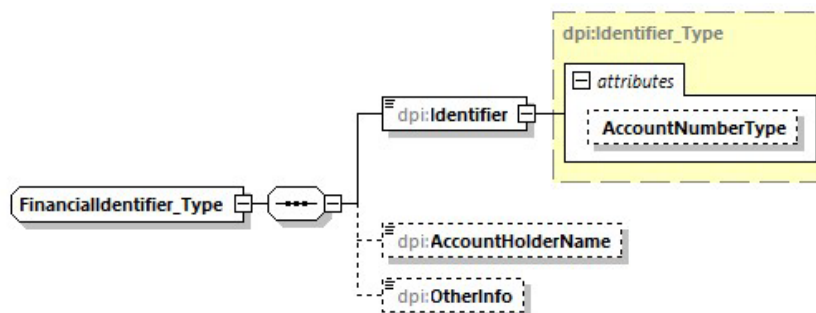

GVS

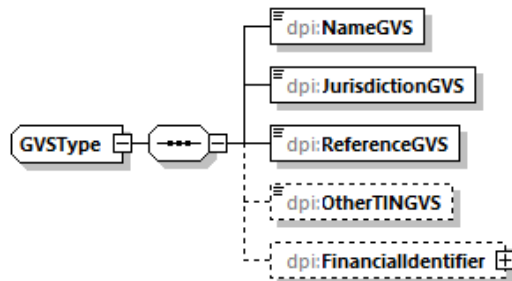

MessageSpec

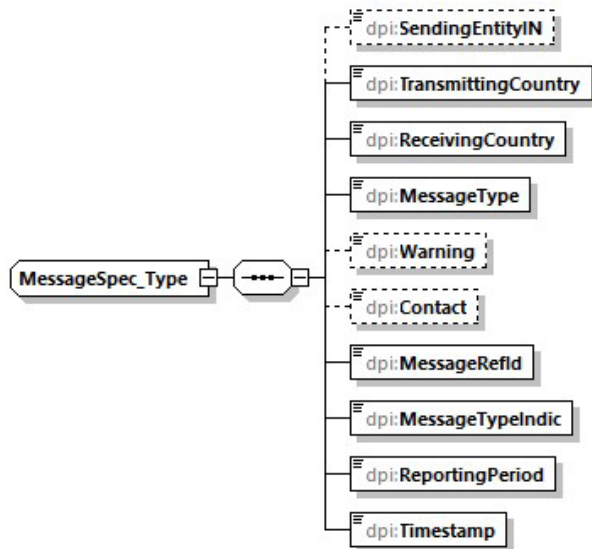

Monetary Amounts

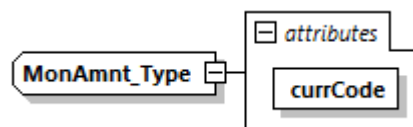

Name of Person

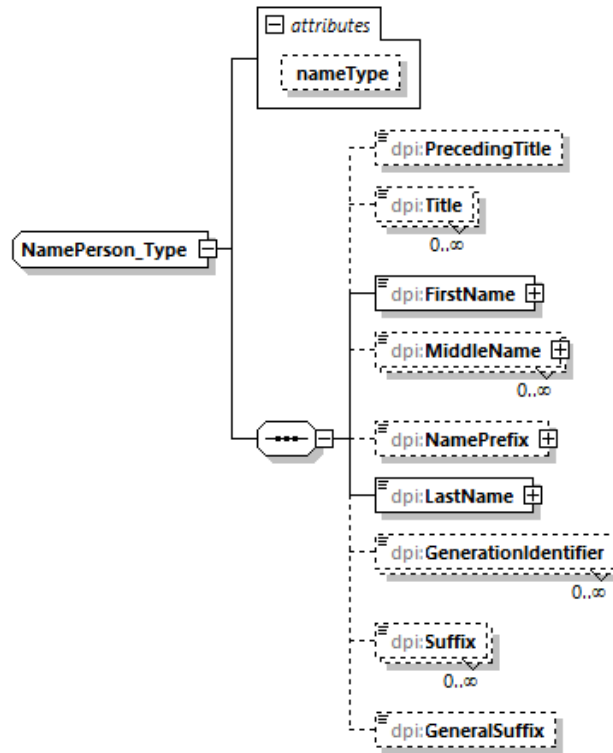

Number of Activities

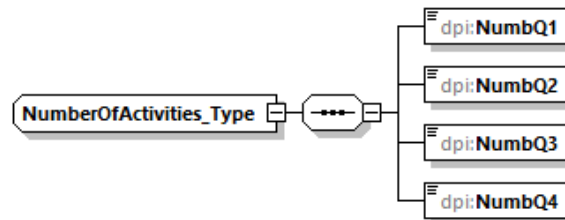

Organisation Party

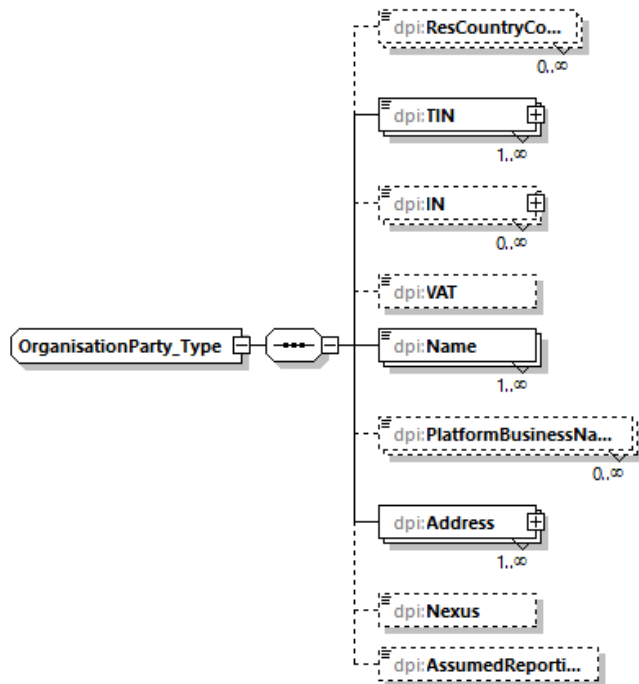

Person Party

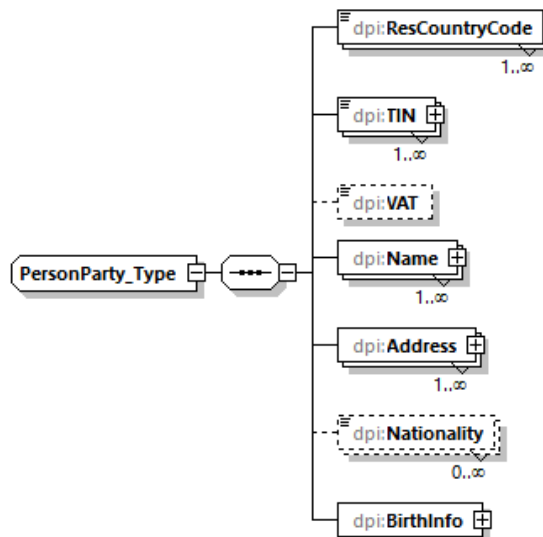

Birth Info

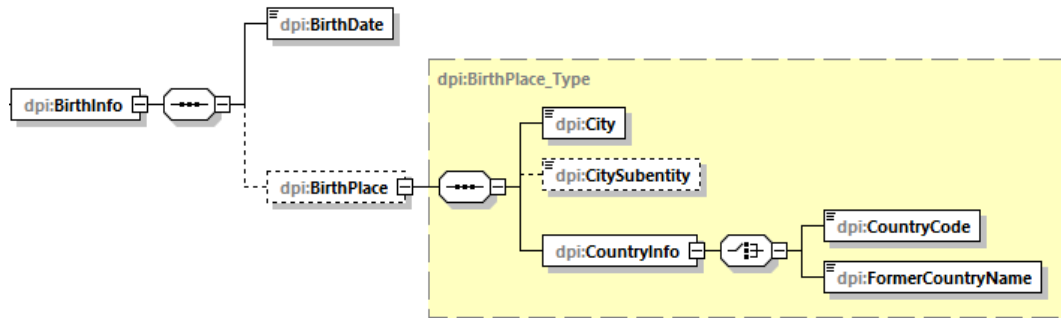

TIN

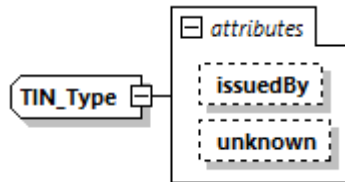

IN

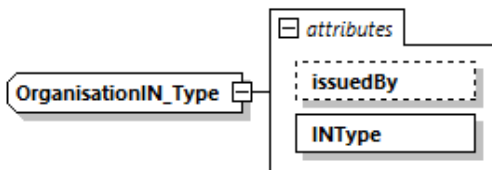

PermanentEstablishments

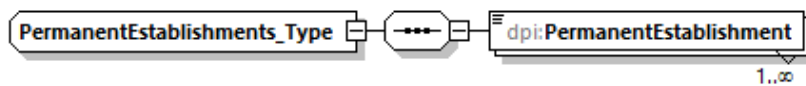

Annex 1.B. Glossary of Namespaces

DPI XML Schema Namespaces

Namespace	Description	Filename
dpi	DPI types	DPIXML_v1.0.xsd
stf	OECD Common types	OecdDPITypes_v1.0.xsd
iso	ISO types (Country, Currency & Language codes)	IsoDPITypes_v1.0.xsd



BETTER POLICIES FOR BETTER LIVES

For more information:

 ctp.contact@oecd.org

 <http://www.oecd.org/tax>

 [@OECDtax](https://twitter.com/OECDtax)

 [OECD Tax](https://www.linkedin.com/company/oecd-tax)